

Operating Instructions **tico 735** – Strain Gauge

Introduction

Your Hengstler **tico 735** Strain Gauge is one model in a family of 1/8 DIN units which offers breakthrough display technology as well as easy-to-program single-line parameters.

Designed to provide instant visual feedback regarding an application's key input value, the **tico 735** not only has a 18 mm high LED display, but also the ability to change display colour based on process status (programmable parameter in Operation Mode). Easy programming is made possible via a help function and a secondary legend display.

This manual will guide you through the installation and wiring of your **tico 735** unit with information on proper panel mounting and rear terminal layout and wiring instructions. In addition, the instrument's operation, programming and configuration modes are thoroughly explained. The operation mode provides day to day operation and allows editing of preset values. The Program Mode enables the configuration of various parameters prior to initial operation. These parameters include those for basic configuration as well as other settable features which will enhance the functionality and usability of the device. The Configuration Mode allows selection of how outputs and special functions are utilized.

This manual also provides information on the **tico 735** instrument's product specifications and ordering information.

Please read the safety information carefully prior to the installation of the unit!



Features

- -100 ... + 100 mV Input range
- Awesome 18 mm high digit LED display
- Programmable colour change display based on an event
- High and Low alarm outputs
- Field selectable 5 or 10 V, 60 mA excitation
- 100 ms Abtastrate bei 0,03% accuracy
- Tare function
- Standard outputs: two NPN transistors & one relay (optional 2nd relay)
- 100 ms sample time with 0.03% accuracy
- Optional RS-485 plug in card

Index

Safety Instructions	2
Installation	3
Operation.....	5
Program Mode.....	8
Configuration Mode	13
Technical Data.....	19

HENGSTLER

Safety Instructions



This symbol indicates passages in the text which you have to pay special attention to so as to guarantee proper use and preclude any risk.

- The range of applications for this product are industrial processes and controls, where the overvoltages applied to the product at the connection terminals are limited to values of the overvoltage category II.
- This device is made and tested according to the valid standards of technics and has left the factory in a perfect safety state. To keep this state and secure operation without danger, the user has to observe the safety and warning hints, contained in this operation manual.
- Assembling and mounting of electrical devices are restricted to be done by skilled electricians! Skilled electrician is, who can judge the tasks deputed to him and foresee possible dangers, due to his special education, knowledge and experience and consciousness of the pertinent standards.
- Mount devices are only allowed to be operated when mounted.
- Terminals which are not used (NC) must not be connected.
- Finger protection at connection part of mount devices is to be secured when mounting!
- While mounting the device, it must be secured that the requirements, which are asked for the device in the pertaining standards for safety, are not affected in a negative way, so reducing the safety of this mount device.
- Mounting and assembling of device needs observation of the specifications of the local Energy Suppliers.
- Before switching on, make sure that the power and control voltages are not exceeding the values in accordance with the technical data.
- If it is to be assumed that operation without danger is not further possible, the device must be put out of operation and secured from unintentional operation! It must be assumed that an operation without danger is not further possible,
if the device shows damage
if the device stops functioning
after a longer stocking period under unfavourable conditions
after heavy strain during transportation.
- If by a failure or a malfunction of the device, endangering of men or animals or damaging of facilities are possible, this must be avoided by additional safety measures (end switches, protection devices and etc.).
- Before opening any cover, the device must be switched voltagefree.
- Hengstler Indicators are intended for industrial applications.
- The mounting environment and nearby cabling have an important influence on the EMC (noise radiation and noise immunity) of the indicator . When putting into operation, the EMC of the whole installation (unit) has to be secured. In particular, the relay outputs are to be protected from high noise radiation by suitable wiring.

Installation

Panel mounting

The instrument can be mounted in a panel with a thickness of up to 12 mm. The cutout should be made based on the recommended panel opening illustrated in the drawing below.

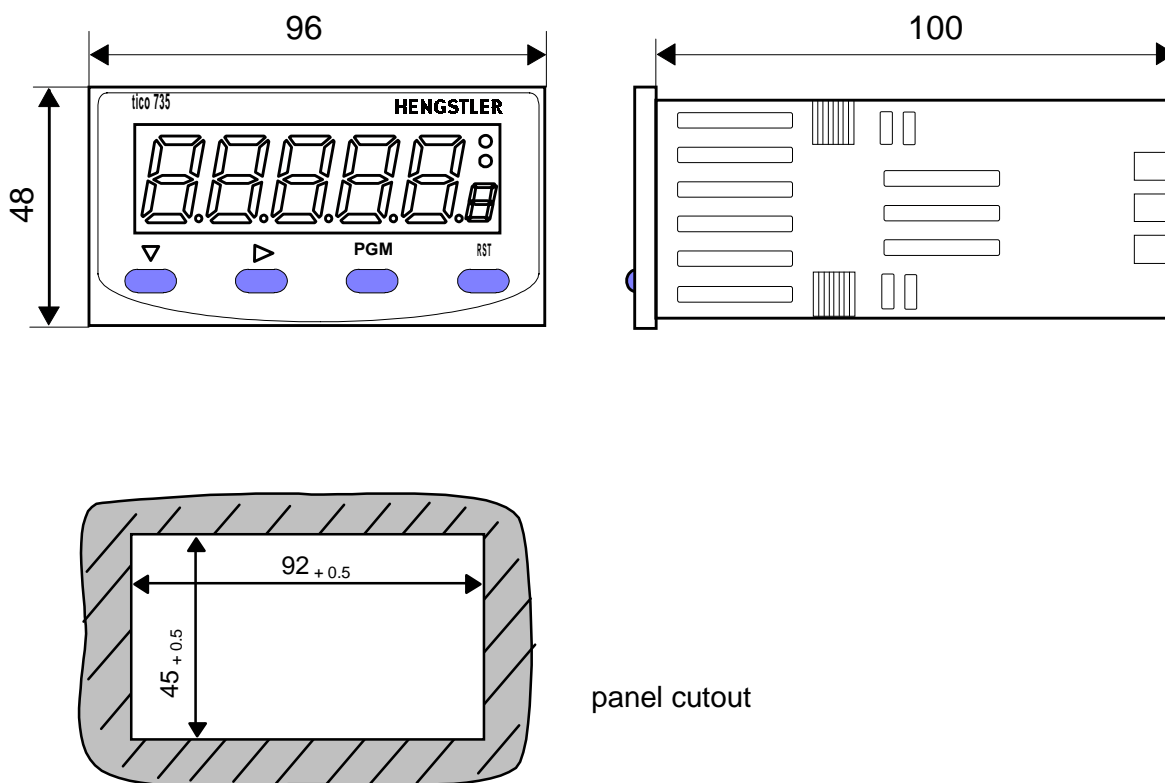

panel cutout

Insert the unit in the panel through the cutout. Ensure that the panel gasket is not distorted and the instrument is positioned squarely against the panel. Slide the mounting clamp into place on the instrument and push it forward until it is firmly in contact with the rear face of the mounting panel and the tabs on the bracket arm are seated in the mounting grooves on the side of the unit.

The electronic components of the instrument can be removed from the housing after installation without disconnecting the wiring. To remove the components, grip the side edges of the panel and pull the instrument forward. Take note of orientation of the unit for subsequent replacement in the housing.



Please finish all settings in the configuration mode prior to scaling the display.

HENGSTLER

Wiring

Rear Terminal Connections

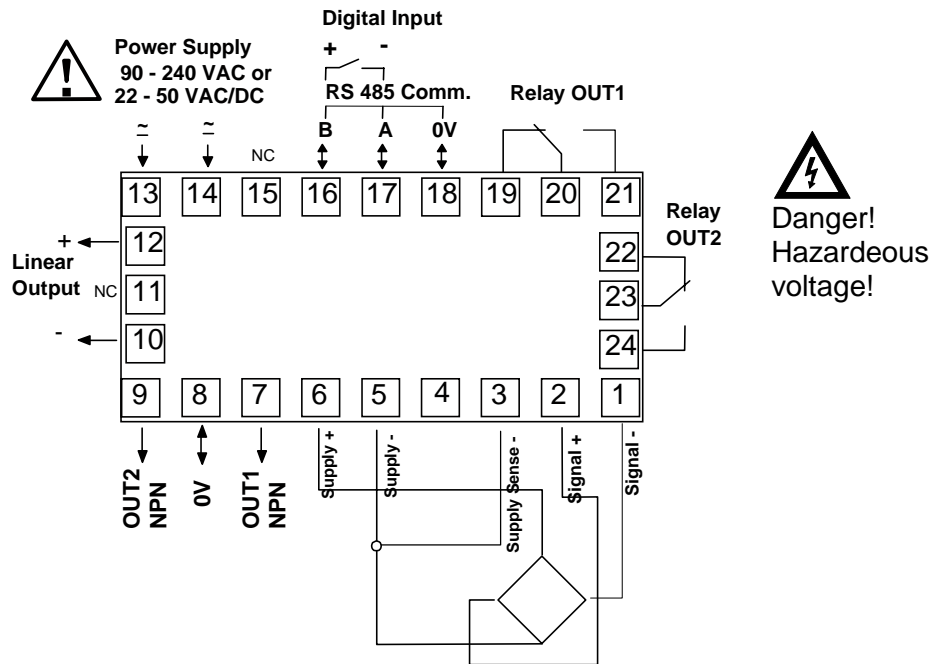

Transistor Outputs

Your unit comes standard with 2 NPN outputs which are activated by each of the alarms. Transistor Output 1, which is tied to Alarm 1, is on Terminal #7. Transistor Output 2, which is tied to Alarm 2, is on Terminal #9. Terminal #8 serves as the common connection for both transistor outputs.

Relay Outputs

Your unit comes standard with a relay output which is tied to Alarm 1. Terminal #19 is NC, Terminal #20 is common, and Terminal #21 is NO. A second relay output tied to the operation of Alarm 2 can be added as an option at the time of order or later installed in the field. Terminal #22 is NC, Terminal #23 is common, and Terminal #24 is NO.

Strain Gauge Inputs

The **tico 735** accepts a 5 wire strain gauge input. Terminals #1 and #2 are used for the negative and positive inputs respectively. Terminal #5 provides the negative side of the bridge excitation, while Terminal #6 is used for the positive supply. Terminals #3 is used to sense the excitation voltage supplied to the bridge and compensate for errors due to lead resistance or drift in the excitation voltage.

Input Power

Terminal #13 and #14 serve as the power supply inputs. Please watch the specified voltage range of the unit.

Control/Digital Inputs

A digital input board, which utilized Terminal #16 & #17 as a contact closure input, can be installed as an option. The input is activated by connecting the Terminals and can be programmed in Configuration Mode to perform the following function:

Tare: When activated, the unit will create an automatic offset by referencing the currently measured value as the new zero point.

Security: When activated, the Program and Calibration Modes will not be accessible from the front panel.

Please note that this option is mutually exclusive with the RS-485 serial communication option.

Serial Communication

An RS-485 communication board, utilizing ASCII protocol, can be installed as an option. Terminals #16 and #17 serve as the B and A connections respectively, while Terminal #18 is connected as the common. Please note that this option is mutually exclusive with the Digital Inputs option.

Linear Output

An option board may be installed that provides a 10 Bit linear output signal relative to the Process Value. Terminal #12 is the positive side of the connection, and Terminal #10 is the negative side. The default range of the output is 4-20 mA, but can be changed via the Configuration Mode to 0-20 mA, 0-10 VDC, 2-10 VDC, 0-5 VDC, or 1-5 VDC.



Terminals 4, 11 & 15 are not used and must not be connected.

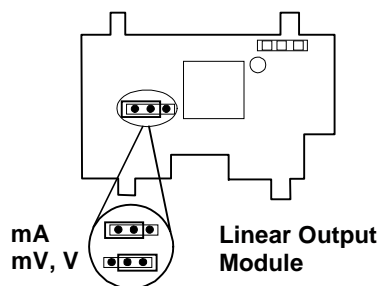





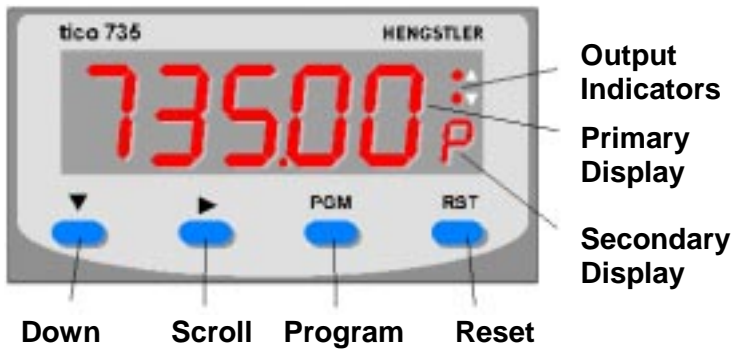

Operation

Front Panel



Key functions

Key	Function
Down 	In <i>Operation Mode</i> : Used in Edit Operation to decrement the digit highlighted by the Scroll Key In <i>Program Mode</i> : Used in Edit Operation to decrement the digit highlighted by the Scroll Key, if the setting is a numerical value, or present the next in the series of choices for that parameter
Scroll 	In <i>All Modes</i> : Moves the unit into Edit Operation, which is indicated by the left most digit flashing. Successive presses of the key are used to move to the digit to be edited. Wrap around will occur from least significant digit to most significant digit.
Program 	In <i>Operation Mode</i> : Used to move between the process value display & the presets and to enter an edited preset value. Holding the key down for 3 seconds will cause the unit to enter the Program Mode. In <i>Program Mode</i> : Used to move from one parameter to the next and enter the edited parameter values. Holding the key down for 3 seconds will cause the unit to return to Operation Mode. In <i>Config. Mode</i> : Used to move from one parameter to the next and enter the edited parameter values.
Reset 	In <i>Operation Mode</i> : Resets a latched alarm if pressed while the process value is being viewed. Pressing this key while viewing the max or min value will cause those values to be reset. In <i>Program & Config. Mode</i> : No function
Down & Scroll 	In <i>All Modes</i> : Will abort an Edit Operation and return the preset/parameter to its previous value.
Down & Program 	In <i>Config. Mode</i> : Holding down both keys for 3 seconds will cause the unit to return to Operation Mode. In <i>Operation & Program Modes</i> : Holding down both keys for 3 seconds will cause the unit to enter to Config. Mode.

Display functions

Display	Function
Primary	In <i>Operation Mode</i> : Default display is the Process value. Can be scrolled using the program key to display other Operations Mode values. If the „Help“ function is enabled, this display will first show the parameter description for 3 seconds (example - page 7). In <i>Program & Config. Modes</i> : Displays the value or selection for the current parameter. If the „Help“ function is enabled, this display will first show the parameter description for 3 seconds (example - page 7).
Secondary	In <i>Operation Mode</i> : Provides an alpha or numeric identification of the value on the primary display. This display is blank when the Process Value is being shown. In <i>Program Mode</i> : Provides a 1 digit alpha or numeric character to indicate which parameter value is being shown on the primary display.
Output indicators	In <i>Operation Mode</i> : Illuminates when Output 1 and / or Output 2 is active. In <i>Program & Config. Modes</i> : No function

HENGSTLER

Operation Mode

Operating Displays

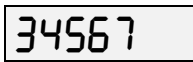

Default display is the process value.

PGM



Pressing the Program Key will cause the display description to appear on the main display.* If there is no key activity for 3 seconds, the primary display will switch back to the count value.

PGM

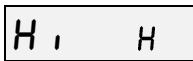

Maximum (High) Value: Displays the maximum process value the unit has received as an input. The value can be reset (only while being displayed) by pressing the Reset Key.

PGM



Minimum (Low) Value Displays the minimum process value the unit has received as an input. The value can be reset (only while being displayed) by pressing the Reset Key.:

PGM

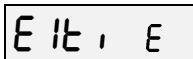

Alarm 1 Elapsed Time: Displays the accumulated amount of time the alarm 1 condition was present. This value will continue to accumulate until it is reset by pressing the Reset key (while the value is being displayed). The value is displayed in mm:ss up to 99 min 59 secs., then changes to mmm.m

PGM

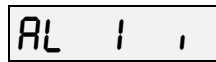

Alarm 1 Value: Defines the process value at or above which Alarm 1 will activate if set to Process High Alarm in Configuration Mode or the process value at or below which Alarm 1 will be active if set to Process Low Alarm in Configuration Mode. The default value is 100.00

PGM

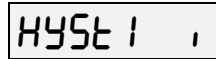

Hysteresis 1 For Alarm 1. The statement effects on % from the max display range (see example on page 11)

PGM

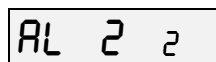

Alarm 2 Value: Defines the process value at or above which Alarm 2 will activate if set to Process High Alarm in Configuration Mode or the Process value at or below which Alarm 2 will be active if set to Process Low Alarm in Configuration Mode. The default value is 100.00

PGM

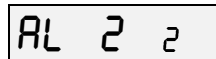

Hysteresis 1 For Alarm 2. The statement effects on % from the max display range (see example on page 11)

PGM

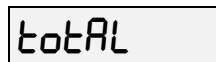

Total: Displays the total value based upon integration of the input signal using a programmable time base. The value can be reset (only while being displayed) by pressing the Reset Key.

* Parameter descriptions will not appear on the primary display if the „Help“ function has been disabled.

Other Operation Displays

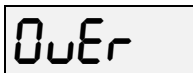

Over Range Display: Appears if the scaled process value becomes higher than the display value equivalent to the input full scale value.

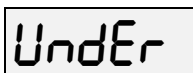

Under Range Display: Appears if the scaled process value becomes lower than the display value equivalent to the input low scale value.

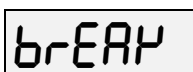

Sensor Break Display: Appears at the following:

- The unit does not receive an input signal for two seconds (valid for input range with offset)
- The process input value is approx. 15% over the maximum of the selected input range, independent of scaling and offset

Changing an Alarm value (example)

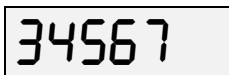

Default display is the process value.

 5 Times

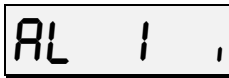

From the Process Value display, scroll through the other Operation Mode values until Alarm 1 appears.*



To change the Alarm value, press the Scroll Key. If there was no key activity for 3 seconds, the Alarm value will appear (one digit description shown on secondary display); however, press the Scroll Key in order to edit. The unit will now be in Edit Operation as signified by the most significant digit flashing.**

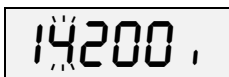

Use the Scroll Key to move from left to right and highlight the digit that needs to be changed. Wrap around will occur from the least significant to the most significant digit.



Use the Down Key to decrement the digit until the desired value appears. The display will wrap around from 0 to 9.



After the desired digits have been changed, press the Program Key to enter the new value. The new value will appear on the main display without any flashing digits. Press the Program Key again and the parameter description will appear on the main display.

* Parameter descriptions will not appear on the primary display if the „Help“ function has been disabled.

** Edit Operation cannot be accessed if the Preset Lock has been enabled in Program Mode.

HENGSTLER

Program Mode

Entering Program Mode and Basic Operation

The Program Mode can be **accessed** from the Operation Mode by holding the Program Key for 3 seconds.

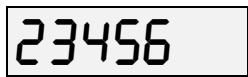

↑ PGM ↓
for 3 secs.

The name of the first parameter will appear on the primary display.*

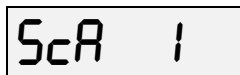

3 secs. or



← PGM

Successive presses of the Program Key will scroll the display through the remaining parameters in the Program Mode. To **exit** Program Mode, hold the Program Key for 3 seconds.

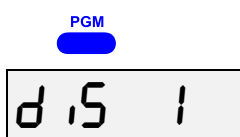

Edit Operation



Pressing the Scroll Key or no key activity for 3 seconds will display the value for that parameter. The secondary display will indicate the one-digit identifier for the parameter. The digit in the secondary display will flash to indicate the unit is in Program Mode. If the Scroll Key was pressed (instead of waiting 3 seconds), the unit is in Edit Operation, as indicated by the MSD flashing. If there had been no key activity for 3 seconds, press the scroll key to enter Edit Operation (MSD flashing). Use the scroll and edit keys to change the value as in Operation Mode, described on page 5. Press the Program Key to enter any changes.

* Parameter names will not appear on the main display if the „Help“ function has been disabled in Program Mode

Scaling of Inputs

Scaling enables to display the process input value as engineering units.

The simplest method is the **linear scaling** consisting of a straight line being determined by two points S1 and S2.

A scaling point always consists of an input measure value and the assigned display value.

- The input value is entered in mV
- The left bound of the selected input range is -100mV
- The right bound of the selected input range is +100mV
- Negative Scaling is possible
- The full display range of -19999 to 99999 can be used

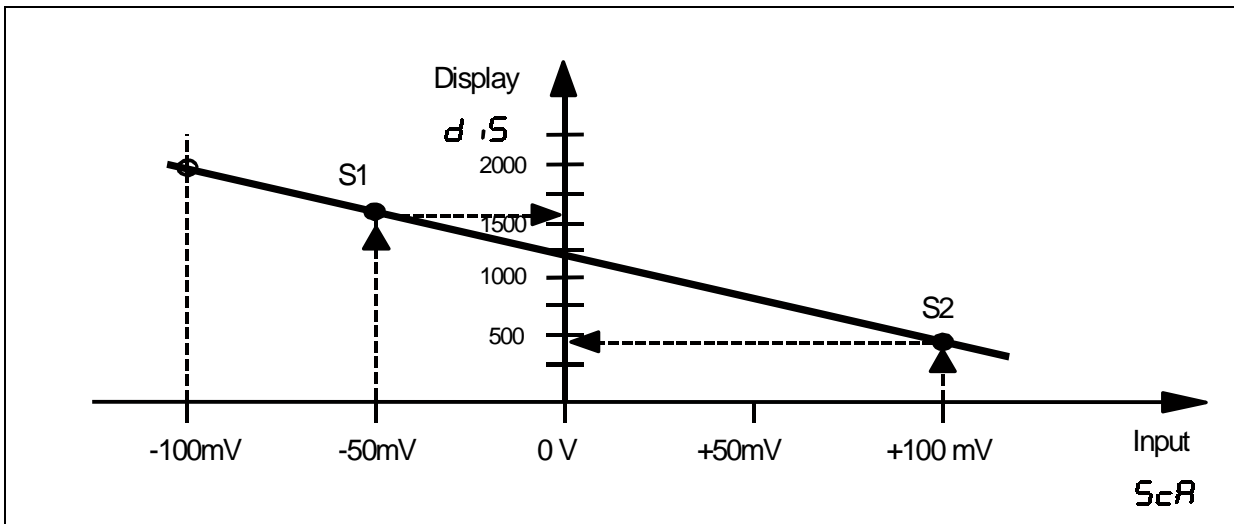

Linear 2-point Scaling

Non-linear scaling is achieved by the definition of a spline, consisting of up to 10 scaling points.

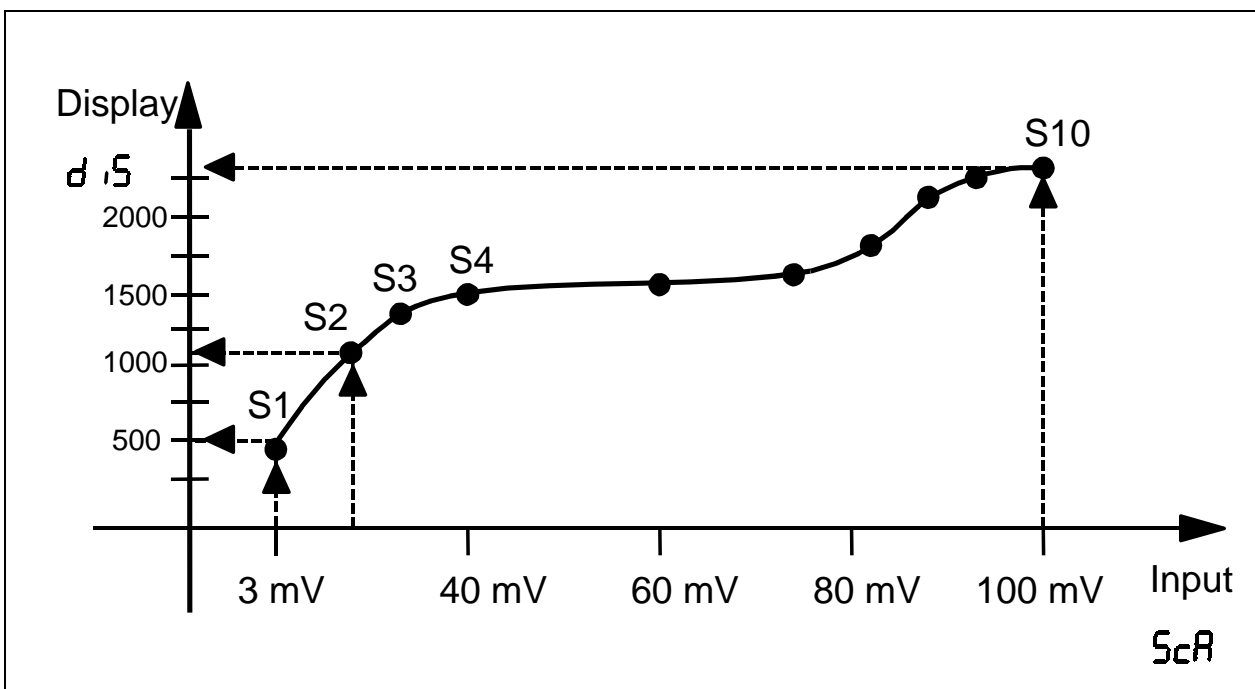

Non-linear Scaling

Comment: The ScA parameters *cannot* be set lower than the previous ScA setting

In the above example, all 10 scaling points are incorporated and their possible values are illustrated as follows:

	ScA	d IS
S1	3.0	500
S2	22.0	1100
....
S9	89.4	2237
S10	100.0	2296

HENGSTLER

Alarm hysteresis

Hysteresis values are given in % of the whole display range.

Example: Smallest display value is -200, biggest value is 800 (see also display scaling). The display range in this case is 1000. If you set the hysteresis to 5% this result in an effective hysteresis of 50 – independent of the absolute setting of the alarm value.

Alarm type **Process High**

Display range: 0-1000

Hysteresis (5.00%) = 50

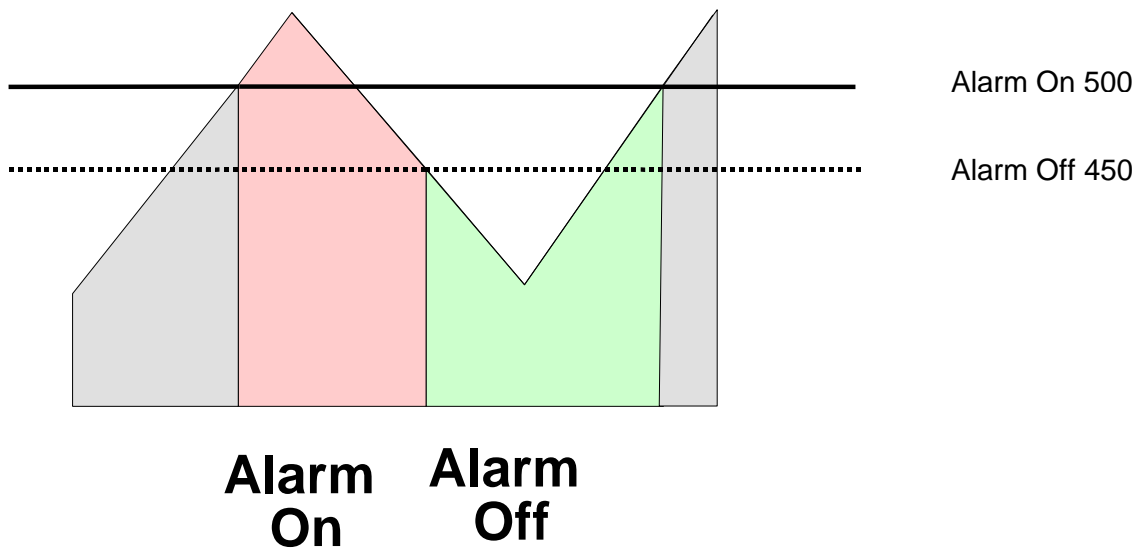

Alarm type **Process Low**

Display range: -300...700

Hysteresis (5.00%) = 50

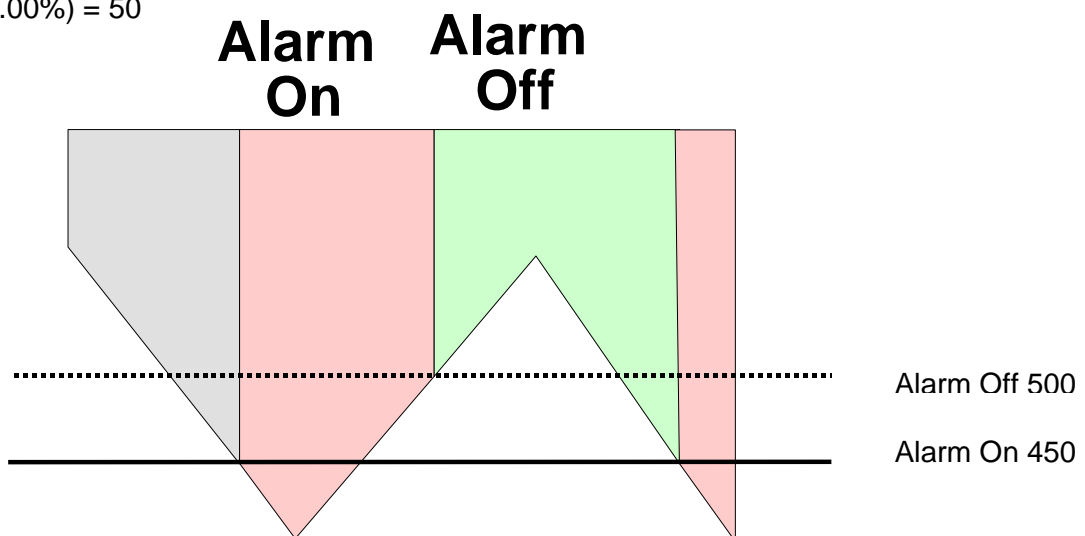

Parameter Sequence

ScA 1 1



Scaling Point 1

Function: Sets the first sensor input value point which will be used in establishing a curve for scaling sensor inputs into engineering unit values. Pressing the Reset Key will serve as a teach function and input the sensor value currently being read which will automatically be converted and shown as percentage value.

Adjustment Range: -100.00 to 100.00 (mV)

Default Value: 0.00

d 15 1 1



Display Point 1

Function: Provides the engineering unit value that will be displayed corresponding to the sensor input value set in the Scaling Point 1 parameter.

Adjustment Range: -19999 to 99999

Default Value: 0.00

ScA 2 2



Scaling Point 2

Function: Sets the second sensor input value point which will be used in establishing a curve for scaling sensor inputs into engineering unit values. Pressing the Reset Key will serve as a teach function and input the sensor value currently being read which will automatically be converted and shown as percentage value.

Adjustment Range: -100.00 to 100.00 (mV)

Default Value: 100.00

d 15 .2



Display Point 2

Function: Provides the engineering unit value that will be displayed corresponding to the sensor input value set in the Scaling Point 2 parameter

Adjustment Range: -19999 to 99999

Default Setting: 0.00

The scaling process can be repeated up to a total of 10 scale and display points.

Scale and display points will continue to be offered (up to 10 total) so long as 100.00 (the maximum input range) has not been selected as a scaling point.

dEc P d



Decimal Position

Function: Sets the position of the decimal point for use in displaying the process and alarm values.

Adjustment Range: -19999 to 99999

Default Values: 100.00

rt Lo L



Retransmission Scale Minimum (Appears only if a retransmission output has been enabled in Configuration mode)

Function: Defines the lower end of the linear scale for the retransmission output by defining the value equated to the minimum output signal.

Adjustment Range: -19999 to 99999

Default Value: 0.00

rt Hi H



Retransmission Scale Maximum (Appears only if a retransmission output has been enabled in Configuration mode)

Function: Defines the upper end of the linear scale for the retransmission output by defining the value equated to the maximum output signal

Adjustment Range: - 19999 to 99999

Default Value: 100.00

oFF 0



Process Variable Offset

Function: Corrects a known offset of the input in order to more accurately display the process value. An offset value Δ_{inp} is added to the internal input signal, such as:

$$\Delta_{inp} = oFF * (d 152 - d 15 1) / (ScA2 - ScA 1)$$

The offset value is retained at power off.

Adjustment Range: -19999 to 99999

Default Value: 0.00

HENGSTLER

Filt F



Input Filter Time

Function: Filters the input over a user definable time period to minimize the effect on the Process Value of any extraneous impulses.

Adjustment Range: 0.0 (Off) to 100.0

Default Value: 1

Addr A



Communication Address (Appears only if communication board is installed and activated)

Function: Defines the unique communication address of the instrument

Adjustment Range: 1 to 99

Default Value: 1

bAud b



Baud Rate

(Appears only if communication board is installed and activated)

Function: Selects the serial communication speed

Adjustment Range:

1200 b

1200 BPS

2400 b

2400 BPS

4800 b

Default: 4800 BPS

9600 b

9600 BPS

Color o



Display Colour Change

Function: Defines the colour of the display for prior to and after an alarm value is active.

Adjustment Range:

red o

Red: The display will always be red

GrEEen o

Green: The display will always be green

Grn_rd o

Green to Red: The display will be green when no alarm condition is present. It will turn red when either alarm is active

rd_Grn o

Red to Green: The display will be red when no alarm condition is present. It will turn green when either alarm is active.

Default Value:
Green to red

Lock P



Alarm Lock and alarm reset lock

Function: Determines whether the Alarm Values can be changed via the front panel.

Adjustment Range:

En P

Locking Enabled:
Alarm values are read only

dis P

Locking Disabled:
Alarm values can be viewed and changed

Default Value: Disable

HELP h

Help Prompt

Function: Determines whether the multi-character parameter name will appear on the main display for 3 seconds prior to the parameter value appearing.

Adjustment Range:

HLP y h

Help-Yes: Multi character parameter descriptions will appear on the primary display. The value associated with that parameter will appear by pressing the scroll key or waiting for 3 seconds

HLP n

Help-No: Only the parameter values will appear on the primary display. The parameter can be identified by a single digit in the secondary display

Default Value:
Help Yes

Configuration Mode

Entering Configuration Mode and basic operation

The Configuration Mode can be **accessed** from the Operation Mode by holding the Down and Program Keys for 3 seconds.

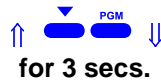
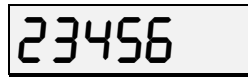

The name of the first parameter will appear on the primary display.*

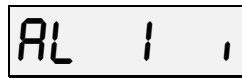

3 secs. or



Edit Operation



Successive presses of the Program Key will scroll the display through the remaining parameters in the Configuration Mode. To **exit** Configuration Mode, hold the Down and Program Keys for 3 seconds.

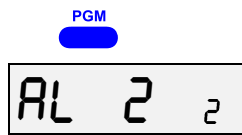

Pressing the Scroll Key or no key activity for 3 seconds will display the value for that parameter. The secondary display will indicate the one-digit identifier for the parameter. The digit in the secondary display will flash to indicate the unit is in Configuration Mode. If the Scroll Key was pressed (instead of waiting 3 seconds), the unit is in Edit Operation, as indicated by the MSD flashing. If there had been no key activity for 3 seconds, press the scroll key to enter Edit Operation (MSD flashing). Use the scroll and edit buttons to change the value as in Operation Mode, described on page 6. Press the Program Key to enter any changes.

* Parameter names will not appear on the main display if the „Help“ function has been disabled in Program Mode.

Comment: The automatic return in the display mode effects, after 120 seconds without button activity

HENGSTLER

Parameter Sequence

FrEQ F

Power Supply Frequency

Function: Although the instrument is designed to handle either 50 or 60 Hz inputs automatically, to ensure proper filtering of the input signal, it is necessary to set the input frequency of the primary input power. This parameter appears only on DC-powered units.

Adjustment Range:

50 F

60 F

Default Value: 50



50 Hz

60 Hz

AL 1 1

Alarm 1 Type

Function: Sets the action of the alarm to one of the following choices:

Adjustment Range:

P_H 1

P_Lo 1

nonE 1

Default Value: Process High Alarm



Process High: Alarm will activate when the process value equals or exceeds the Alarm 1 setting

Process Low: Alarm will activate when the process value equals or is less than the Alarm 1 setting

No Alarm: Alarm 1 will be activate.

AL 2 2

Alarm 2 Type

Function: Sets the action of the alarm to one of the following choices:

Adjustment Range:

P_H 2

P_Lo 2

nonE 2

Default Value: No Alarm



Process High: Alarm will activate when the process value equals or exceeds the Alarm 2 setting

Process Low: Alarm will activate when the process value equals or is less than the Alarm 2 setting

No Alarm: Alarm 2 will be activate.

Out 1 U

Output 1 Usage

Function: Determines how the transistor and relay for output 1 will operate

Adjustment Range:

A Ind U

A Inr U

A ILd U

Alarm 1, Non latching, Direkt Action: The output will be On when Alarm 1 is activate, and turn Off once the Alarm 1 condition is no longer present

Alarm 1, Non latching, Reverse Action: The output will be On when Alarm 1 is inactive, and turn Off when the Alarm 1 condition is present

Alarm 1, Latching, Direct Action: The output will be On when Alarm 1 is activate, and turn Off only when reset via the front panel

A ILr U

O 12d U

O 12r U

Alarm 1, Latching, Reverse Action: The output will be On when Alarm 1 is inactive, and turn Off only when reset via the front panel

Logical OR of Alarm 1 & 2, Direct Action: The output will be On when a logical OR condition between Alarm 1 and Alarm 2 is present.

Logical OR of Alarm 1 & 2, Reverse Action: The output will be On when a logical OR condition between Alarm 1 and Alarm 2 is not present.

Default Value: A Ind



Out2 u

Output 2 Usage

Function: Determines how the transistor and relay for output 1 will operate
Adjustment Range:

A2_d u

A2_r u

0 12d u

0 12r u

PGM

Alarm 2, Direct Action:
The output will be On when Alarm 2 is activate, and turn Off once the Alarm 2 conditions is no longer present (=Default)

Alarm 2, Reverse Action:
The output will be On when Alarm 2 is inactive, and turn Off when the Alarm 2 conditions is present

Logical OR of Alarm 1 & 2, Direct Action:
The output will be On when a logical OR condition between Alarm 1 and Alarm 2 is present

Logical OR of Alarm 1 & 2, Reverse Action:
The output will be On when a logical OR condition between Alarm 1 and Alarm 2 is not present

rt En t

Retransmission Output

Function: Selects the range of the retransmission output

Note: The linear output modul is preconfigured for current output (jumper positioned on outer 2 Pins). If you opt to use the voltage output, please jumper the modul on the inner two pins). Refer to the chapter Installation for how to open the unit.

Adjustment Range:

none t

0-5u t

0-10u t

0-20A t

PGM

None: deaktiviert
Standardwert: none

1-5u t

0-5 or 1-5 Volt

2-10u t

0-10 or 2-10 Volt

4-20A t

0-20 mA, 4-20mA

Optn o

Option Selection

Function: Determines the function of the board installed in the option slot
Adjustment Range:

none o

Sct o

tArE o

CoM75 o

PGM

No Input

Security: When the digital input is active, the Program and Configuration Modes cannot be accessed

Tare: When the digital input is activated the currently measured value is zeroed out and will remain as a contant offset.

Communication: The slot will be used for RS-485 communication

Default Value:
None

Power P

Excitation Power Supply

Function: Select the voltage level supplied to the strain gauge

Adjustment Range:

5u P

10u P

5 VDC

10 VDC

Default Value: 5 VDC

PGM

tot t

Totaliser

Function: Determines the time period after which the total value equals the maximum input value. Example: maximum input value is 25. With a setting of hr (hour) and a continuously applied input of 25 the total amounts to 25 after one hour and to 50 after two hours etc.. If the process display is set as gallon per hour the total display directly reads the volume. Please consider that large process values may lead to an early overflow of the total; in order to prevent this, you may reduce the number of digits of the process display.

The total value is updated synchronously to the sample rate (every 100 ms).

Adjustment Range:

Sec t

mn t

hr t

in one second

in one minute

in one hour

PGM

Default Value:
one second

HENGSTLER

Notes:

Notes:

HENGSTLER

Notes:

Technical Data

Display and Keyboard	Primary Display	Red/Green, 7 segment LED, 5 digits, height 18.5 mm
	Secondary Display	Red/Green, single digit 7 segment LED, height 7 mm
	Annunciators	2 red LEDs for OUT1 and OUT2
	Keyboard	4 rubber keys for programming and manual reset
Physical	Dimensions	DIN 48 mm x 96 mm, 110 mm total depth
	Mounting	Front panel mounting (mounting bracket supplied)
	Panel Cutout	45+0.5 mm x 92+0.5 mm, panel thickness max 12 mm
	Construction	Front carrier with circuit boards can be pulled out
	Material	GE Lexan 940
	Terminals	Screw Type - combination head
	Environmental	Power Supply
Power Consumption		90-264 VAC : <4 Watt; 24 V : <200 mA
Temperature		Operation: 0°C to +55°C (32°F to 131°F) Storage: -20°C to +80°C (-4°F to 176°F)
Relative Humidity		20 % to 90 %, non-condensing
Approvals	Ratings	Frontpanel IP 66
	EMC Susceptibility	Complies with EN 50082-1/92 and EN 50082-2; see notes 1), 2)
	EMC Emissions	Complies with EN 50081-2/94
	Safety	DIN EN 61010 part 1; according to protection class II
	General	Overvoltage category II, Contamination level 2, UL, CUL
Process Input	Range	0-100 mVDC
	Accuracy/Resolution	± 0.03% of span / 14 bits
	Sample Rate	100 ms
	Sensor Break	Detected within 2 seconds
Control Input Option	Digital Input	Edge sensitive; PNP; High ≥ 3.0 V, Low < 2.0 V or open; 4.7 kOhm to V+ 25 ms min., max 30 VDC; function programmable
Outputs	OUT1, OUT2 NPN	Open Collector; 30 VDC max; 100 mA max; response time < 75 µs
	OUT1, OUT2 Relay	SPDT Changeover; 240 VAC / 3A or 115 VAC / 5A; pull-in time approx. 8 ms
	Hysteresis	1 digit
Aux. Power	Sensor Power Supply	Selectable 5 of 10 VDC @ 60 mA
Linear Output Option	Isolation	Optically isolated; 250 VAC / 400 VDC against all other inputs and outputs.
	Output Range	0-20 mA, 4-20 mA, 0-5 V, 1-5 V, 0-10 V, 2-10 V
	Accuracy	± 0.25 % (mA at 250 Ohm, V at 2kOhm); Linear Deviation ± 0.5%
	Resolution	8 bits in 250 ms (10 bits in 1000 ms typ.)
	Updating	approx. 4 updates per second
RS-485 Option	Type	RS485, serial asynchronous, Open ASCII, Master-Slave, up to 99 zones
	Parameters	9600...1200 Bd, 1 start, 7 data, 1 stop, even parity

1) For RF electromagnetic fields (10V/m 80% AM 1KHz), the reading accuracy may be impaired by up to –0.3% in the frequency band 87-109MHz

2) For line-conducted disturbances induced by RF fields (10V 80% AM 1kHz), the product is self recoverable in the frequencyband 0.15-0.73 MHz

HENGSTLER

Ordering Information

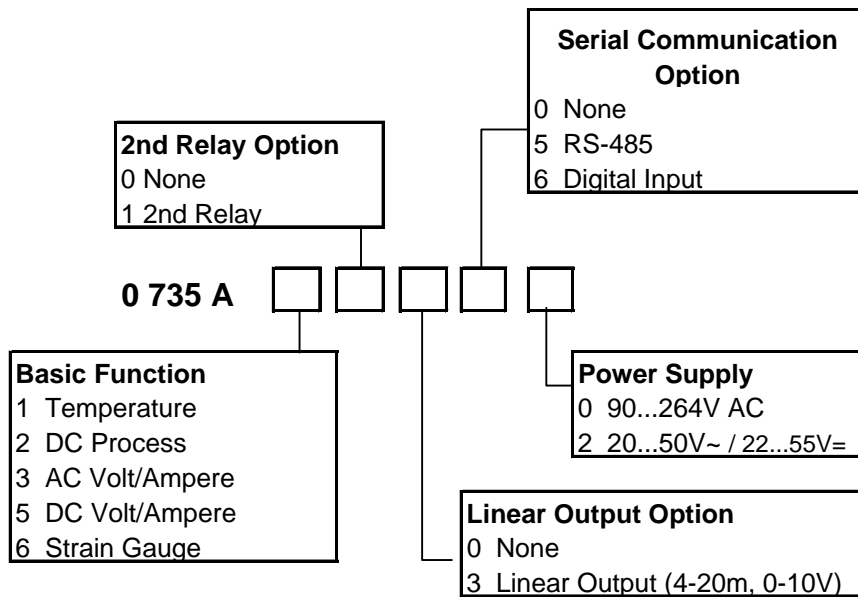

For further information, please visit our homepage:

<http://www.hengstler.de>

The completely operating instructions, can be found in the download area of counters (2735001.pdf)

© 1998 HENGSTLER GmbH

This documentation may not be changed, amended, or copied without prior written consent of HENGSTLER GmbH, and may not be used in contradiction to this company's rightful interests.

HENGSTLER

Hengstler GmbH
Postfach 11 51
D-78550 Aldingen
Germany
Tel. +49-7424-89 539
Fax +49-7424-89 470

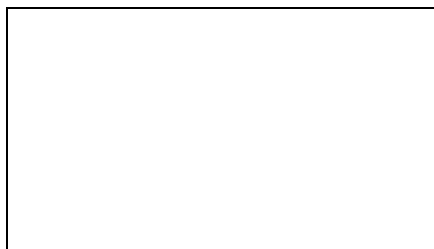

Member of the **DANAHER CORPORATION** U.S.A