

Robotic Automation Application

SERVO DUTY Encoders and Resolvers

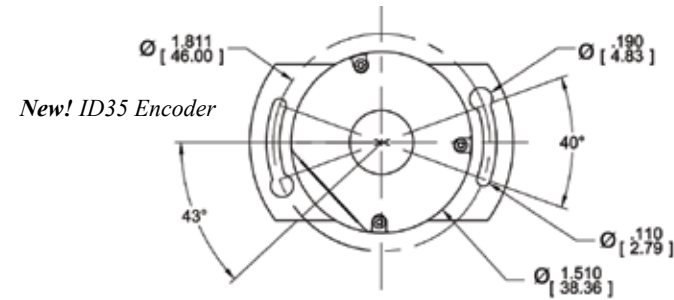

The use of servo motor has been growing rapidly thanks to their increased affordability. As a viable alternative to pneumatic, hydraulic, and some electromechanical forms of motion and positioning control, servo units have been used in a variety of applications, including **robotics**, **XYZ tables**, **factory automation**, and **related precision control operations** in production facilities worldwide.

To learn more about Dynapar's Servo product offerings, visit www.dynapar.com.

Motion Feedback Encoders & Resolvers for Servo Duty Applications

Precise Engineering for High Speeds and Temperature



Robotic Automation Application

We also offer Industrial Duty Encoders



22 Qube Encoder
Optical - Incremental



HS35R Encoder
Optical - Incremental



AC110 Encoder
Optical - Absolute

Often considered the "workhorse" of the encoder world, **industrial duty encoders** achieve a good compromise between ruggedness and performance. These encoders are typically used in factory environments where contaminants like dust and moisture are common. The hollow-shaft variety of industrial duty encoders is often the preferred choice of vector motor OEM's for speed feedback.

To learn more about Dynapar's Industrial product offerings, visit www.dynapar.com.



1675 Delany Rd.
Gurnee, IL 60031
Toll Free: 1.800.873.8731
www.dynapar.com



ID35 Encoder

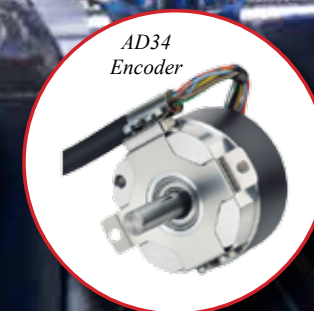

AD34 Encoder



Frameless 10 Resolver



1675 Delany Rd.
Gurnee, IL 60031
Toll Free: 1.800.873.8731
www.dynapar.com





Precise Engineering for Precise Applications.

SERVO DUTY Encoders and Resolvers

Dynapar standardized and customized brand motor mount encoders and Harowe brand resolvers are reliable, affordable and extremely compact in size to enable production personnel to monitor critical motor speed and position parameters within their motion control and production applications. Accurate motor speed tracking ensures optimum machine performance and operation designed to prevent motor burnout, or worst case, costly machine shutdown.

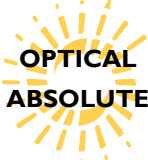





FEATURES:



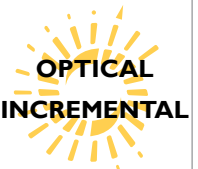



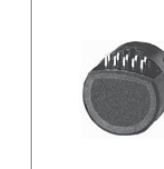

- Specifically suited for stepper and servo motors
- Capable of very high speeds and high temperatures
- Cost-effective, meet a variety of Servo applications
- High efficiency, small size, and high torque technology

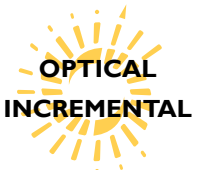
				
Product	AD34	AD35	AD36	AD25
Shaft/Bore Sizes	6mm	8mm	8mm	10mm
Available Resolutions (Bits)	Up to 19 bit Singleturn	Up to 22 bit Singleturn	Up to 22 bit Singleturn, 12 bit multiturn	Up to 22 bit Singleturn, 12 bit multiturn
Input Voltage (VDC)	5 or 7 to 30	5 or 7 to 30	5 or 7 to 30	5
Operating Temperature (°C)	-15 to +120	-15 to +120	-15 to +120	-15 to +120
Enclosure Rating	IP40	IP40	IP40	IP40
Key Features	Unique one-step notched shaft mounting	Short mounting depth	Up to 22 bit singleturn resolution	Unique conical shaft for concentric motor mounting

									
Product	I1	R11	Frameless 10	Frameless 15	Frameless 21	Frameless 31	Frameless 55	HaroMax 15	HaroMax 21
Shaft size/ Max bore size	0.120" (3.05mm)	0.120" (3.05mm)	0.25" (6mm)	0.472" (12mm)	0.800" (20mm)	1.576" (40mm)	3.651" (93mm)	0.472" (12mm)	0.800" (20mm)
Accuracy (Single Speed Only)	+/- 3 arcmin	+/- 6 arcmin	+/- 15 arcmin	+/- 10 arcmin	+/- 7 arcmin	+/- 20 arcmin	+/- 30 arcmin	+/- 5 arcmin	+/- 5 arcmin
Input Voltage (Vrms)	2 to 26	2 to 6	2 to 12	2 to 12	2 to 12	2 to 12	2 to 12	2 to 12	2 to 12
Operating Temperature (°C)	Up to 155	Up to 155	Up to 200	Up to 200	Up to 200	Up to 200	Up to 200	Up to 200	Up to 200
Key Features	Brushless construction	Brushless construction	Compact mounting depth	Compact mounting depth	Compact mounting depth	Compact mounting depth	Compact mounting depth	Machine wound stator for high accuracy	Machine wound stator for high accuracy

Contact Dynapar today toll free at 1.800.873.8731 to learn more about their Servo product offerings. Visit Dynapar's website at www.dynapar.com.

						
Product	M602/M832 Module	LM/LAM	E9	M9	M14	M15
Shaft/Bore Sizes	1/4" to 10mm	N/A	1.5 to 4mm, .125", .156"	1.5 to 4mm, .125", .156"	3 to 8mm, .1248", .375"	1/8" or 3/8" 6 to 10mm
Available Resolutions (PPR)	1 to 5000	Up to 720 CPI/500 CPI	100 to 512	100 to 512	200 to 1024	200 to 1024
Input Voltage (VDC)	5	5	5	5	5	5 or 12
Operating Temperature (°C)	-40 to +100	-40 to +100	-40 to +100	-40 to +100	-40 to +100	-40 to +120
Enclosure Rating	IP00	IP00	N/A	N/A	N/A	NEMA 1/ IP50 (w/cover)
Key Features	Tool-less gapping	Choice of Digital or Analog Output	Super-compact size for small motors	Up to 512 PPR resolution	Short mounting depth	Easy installation without special tools

							
Product	M53	F10	ID35	F15	F18	F21	HC20
Shaft/Bore Sizes	1/4" to 1/2" 6 to 12mm	6mm	1/4"	3/8"	1/4" to 1/2" 6 to 12mm	1/2"	6mm, 8mm hub or hollow, 9mm tapered
Available Resolutions (PPR)	500 to 2500	1024 to 2048	Up to 5000	1024 to 2048	500 to 1000	1024 to 2048	500 to 2500
Input Voltage (VDC)	5 or 12	5	5	5	5	5	5 or 5 to 26
Operating Temperature (°C)	0 to +120	0 to +120	0 to +120	0 to +120	0 to +120	0 to +120	0 to +120
Enclosure Rating	NEMA 1/ IP50 (w/cover)	N/A	NEMA 1/IP40	N/A	NEMA 1/ IP40 (w/cover)	N/A	IP51
Key Features	Up to 2500PPR with commutation tracks	Compact 1.0" diameter servo ring mount	Easy Installation	Industry standard size 15 servo mounting	Under 2.0" dia package with high 10,000PPR capability	Industry standard size 21 servo mounting	Economical servomotor feedback

LOOKING FOR A DISTRIBUTOR?

Contact Dynapar toll free at 1.800.873.8731 or visit our website at www.dynapar.com.

A NOTE ABOUT RESOLVERS

Frameless resolvers are classified here as Servo Duty for their servo ring mounting. By nature, resolvers are extremely rugged devices with no internal electronics. Resolvers can perform flawlessly in harsh duty applications with severe shock, vibration, contamination, and extreme temperatures.